

LOCAL EXTRACTOR

TERFU

A local extractor with friction joints for worksites where great flexibility is required.

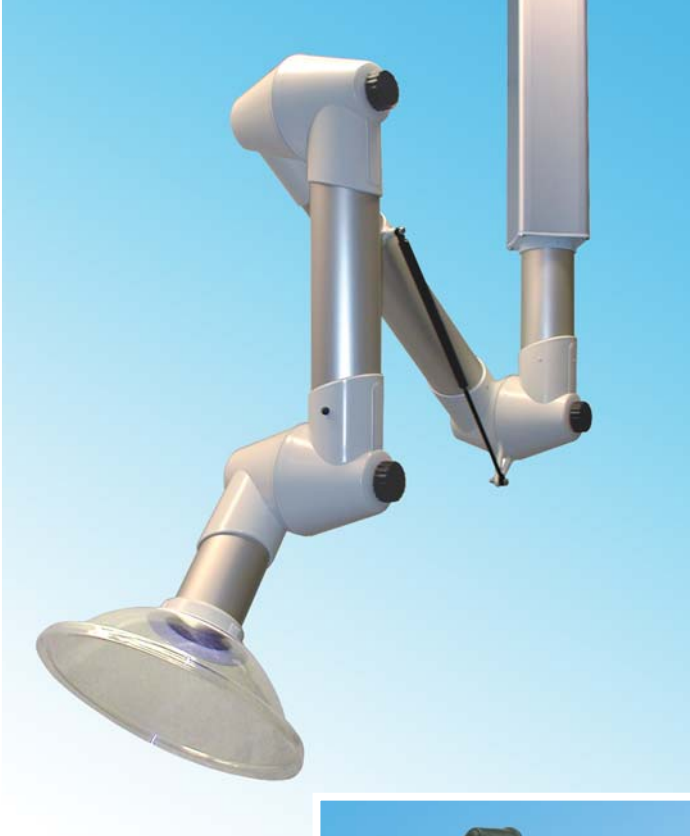

TERFU is a local extractor with friction joints designed for use in workplaces where great flexibility is required e.g. laboratories and production environments in lighter industrial applications.

Simple, easy function

The friction joints have a large frictional diameter and are supported with ball bearings. The degree of friction is easily adjusted with a one-hand knob. Adapted support springs balance out the weight of the arm. All arms are equipped with a 360 degree rotational swivel mounted in place. An air tight damper is fitted as standard.

Always easy to select the right product

Terfu is available in four versions:

- Standard version. Suitable for evacuation of most types of airborne contaminants.
- PP version. Most suitable for evacuation of highly corrosive contaminants in high concentrations.
- ESD version. For ESD environments, type approved to EN 61340-5-1.
- ATEX version. For ATEX classed environments, as in directive 94/9/EC category 2, for gases and dust.

Terfu is available in sizes 50, 75 and 100 mm.

All sizes are suitable for table mounting, ceiling mounting and wall mounting.

The same suction arm is used for suspended mounting from ceilings and walls.

Ceiling and wallbrackets consists of anodised square section aluminium profile for high finish and good stability.

The Ø50 and Ø75 sizes use the same brackets, while the Ø100 size has its own selection of brackets. All ceiling brackets are available in eight standard lengths up to 2 m. Longer lengths can be supplied to special orders.

To further simplify your mounting and provide a neat finish, escutcheon plate MTI CT can be used if it is necessary to cut holes in the false ceiling.

There are six hoods adapted for Terfu 50 & 75 and four specially adapted hoods for Terfu 100.

A suitable air flow is from 20 l/s to 125 l/s.
(75 m³/h - 450 m³/h).

The TERFU system is design protected with several patents- and design protections pending.

The Fumex range also includes fans, accessories, automatic control gear and filters for local extraction

FUMEX®

TERFU models



Standard version of Terfu with polypropylene joints and anodised aluminium tubes. The standard version is available in sizes 50, 75 and 100 mm. The standard version of Terfu is suitable for evacuation of most types of airborne contaminants from e.g. laboratories, schools, hospitals, pharmaceutical industry, hair dressers and light industrial applications.



Polypropylene (PP) version of Terfu with joints and tubes in recyclable PP. All metal parts that come in contact with the airstream are made from acid resistant stainless steel (SS 2343). The PP version is available in sizes 75 and 100 mm. The PP version of Terfu is primarily used for evacuation of extremely corrosive contaminants in high concentrations for e.g. certain laboratories, and also pharmaceutical and chemical industries. When using a ceiling mounted PP extractor, we recommend using an MTI ceiling fixing with internal epoxy surface coating.



ESD version of Terfu with joints made from conducting polypropylene and tubes of anodised aluminium, provides a complete arm that is electrically conductive, thus grounding static electricity to a grounding point. The ESD version is available in sizes 50 and 75 mm. The ESD version of Terfu is suitable for evacuation of airborne contaminants in environments where one wishes to avoid the risk of sparking that may occur due to static electricity. Another area of use is the electronics industry where ESD certification is required. Terfu ESD is type approved to EN 61340-5-1. The demands for ESD certification require that the product does not accumulate and store a charge of 100V for more than 2 seconds.



ATEX version of Terfu with joints and tubes of conductive recyclable PP. All metal parts that come in contact with the airstream are made from stainless steel. Static electricity is lead to a separate grounding point. All load-bearing steel parts have a conductive powder coating. The product fulfils the demands in ATEX directive 94/9/EC category 2, for gases and dust. The ATEX version is available in sizes 75 and 100 mm. The ATEX version of Terfu is suitable for evacuation of airborne contaminants in environments that demand ATEX classed products, e.g. laboratories, chemical and petrochemical industries, gas distribution, paint and pharmaceutical industries. The ATEX directive requires that the resistance shall be $<10^8 \Omega$ to eliminate the risk of dangerous electrostatic charges.

TERFU Maximum flexibility

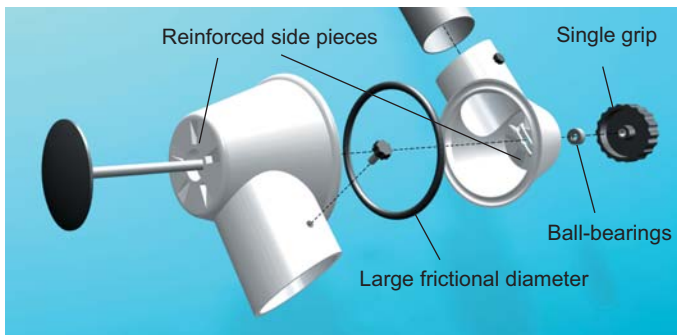

Terfu joint. The large frictional diameter together with the single grip adjusting knob provide a rigid, stable joint with a smooth easily adjustable function without requiring the application of excessive force or tools. The joint has reinforced side pieces that prevent distortion which could cause the O-ring to slide out of place or the joint to crack. Ball bearings that isolate the adjusted friction level allow the arm to move up and down without locking the joint or losing stability and function.

Neat, stable brackets

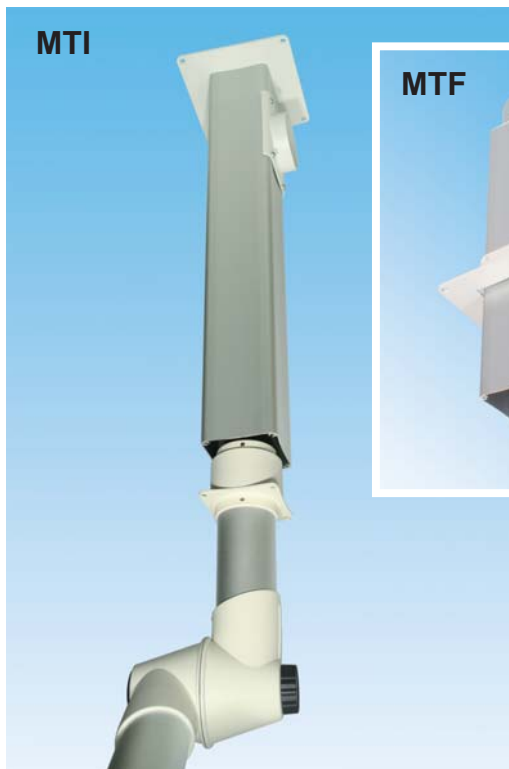

All Terfu extractors have a standard full-swivel that allows 360° of rotation without the need for special sleeves or double wall mountings. Both ceiling and wall brackets consist of a special anodised aluminium profile that provides an appealing, functional installation. The ceiling mount also acts as the extraction channel, thus avoiding the need for expensive external channeling and additional holes in the finish ceiling. Installation is simple and stable, the ceiling mount is available in eight standard lengths, from 0.25 to 2.0 m.

Lengths greater than 2 m can be supplied to order. The ceiling mount can be provided with internal epoxy coating for use in aggressive environments.

Handle for simple adjustment



An easily accessible handle, that provides simple adjustment, is fitted as a standard on all models of Terfu size 100 mm.

TERFU models 50 & 75

Models with two and three joints

Ceiling mount

Designation with three joints				Size (mm)			Weight
Standard	PP	ESD	ATEX	A	B	Ø C	kg
MT 1000-50	-	ES	-	400	300	50	1,50
MT 1300-50	-	ES	-	550	450	50	1,65
MT 1500-50	-	ES	-	750	450	50	1,70
MT 1000-75	PP	ES	EX	400	300	75	2,25
MT 1300-75	PP	ES	EX	550	450	75	2,60
MT 1500-75	PP	ES	EX	750	450	75	2,75
MT 2000-75	PP	ES	EX	1000	650	75	3,25
Designation with two joints							
MT 650-50	-	ES	-	300	-	50	1,00
MT 750-50	-	ES	-	450	-	50	1,10

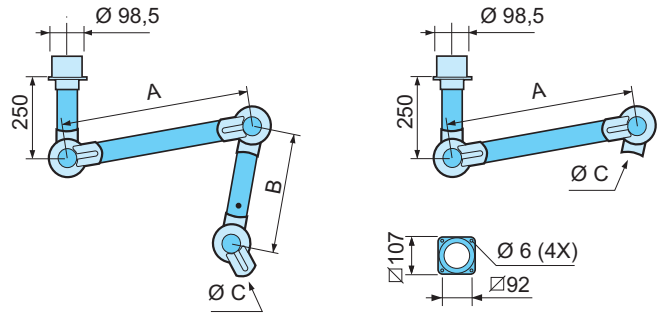

Wall mount

Designation with three joints				Size (mm)			Weight
Standard	PP	ESD	ATEX	A	B	Ø C	kg
MV 1000-50	-	ES	-	400	300	50	3,65
MV 1300-50	-	ES	-	550	450	50	3,80
MV 1500-50	-	ES	-	750	450	50	3,85
MV 1000-75	PP	ES	EX	400	300	75	4,40
MV 1300-75	PP	ES	EX	550	450	75	4,75
MV 1500-75	PP	ES	EX	750	450	75	4,90
MV 2000-75	PP	ES	EX	1000	650	75	5,40
Designation with two joints							
MV 650-50	-	ES	-	300	-	50	3,15
MV 750-50	-	ES	-	450	-	50	3,25

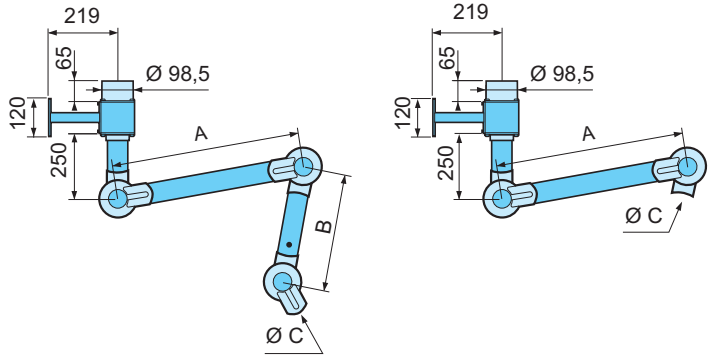

Extractors with designation MV always include a wall bracket

Table mount

Designation with three joints				Size (mm)			Weight
Standard	PP	ESD	ATEX	A	B	Ø C	kg
MB 1000-50	-	ES	-	400	300	50	1,50
MB 1300-50	-	ES	-	550	450	50	1,65
MB 1500-50	-	ES	-	750	450	50	1,70
MB 1000-75	PP	ES	EX	400	300	75	2,25
MB 1300-75	PP	ES	EX	550	450	75	2,60
MB 1500-75	PP	ES	EX	750	450	75	2,75
Designation with two joints							
MB 650-50	-	ES	-	300	-	50	1,00
MB 750-50	-	ES	-	450	-	50	1,10

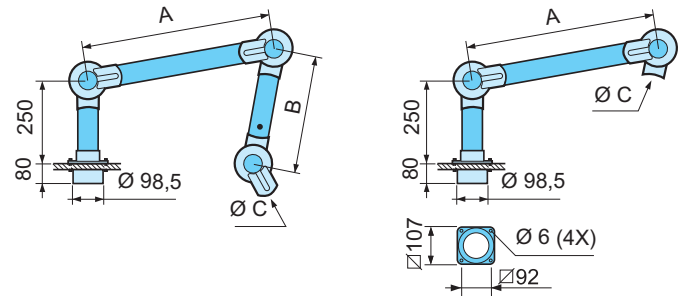

Models with single joint

Table mount

Designation	Weight kg
MBC 700-50 ES	0,80

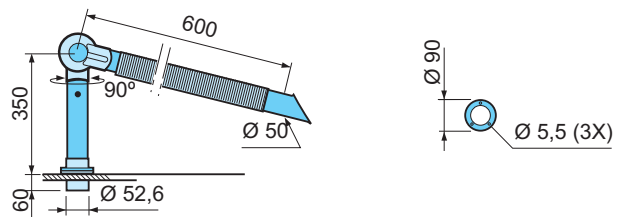

Extractors with designation MB always include a fixing plate

Pressure drop diagram models 50, 75 and 100 mm.

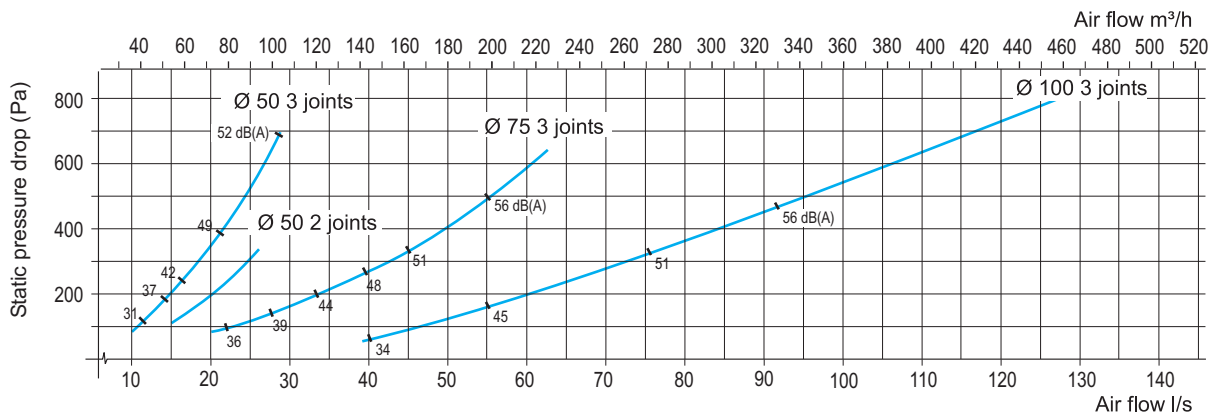

The static pressure drop is measured in accordance with ISO-standard 5167-1. The noise level is measured in accordance with ISO-standard 3741.

TERFU models 50 & 75

All mountings except MBFC suit sizes Ø50 and Ø75 mm and have a ventilation channel connection for Ø100 mm.

Ceiling bracket MTI

Designation for model 50 and 75			Size (mm)	Weight
Standard	ESD	ATEX	L	kg
MTI 250	ES	EX	250	3,15
MTI 500	ES	EX	500	3,80
MTI 750	ES	EX	750	4,50
MTI 1000	ES	EX	1000	5,15
MTI 1250	ES	EX	1250	5,80
MTI 1500	ES	EX	1500	6,45
MTI 1750	ES	EX	1750	7,10
MTI 2000	ES	EX	2000	7,75

Ceiling bracket can be fitted with sleeves both below and above a false ceiling, in the latter case preferably together with MTI CT. MTI can be supplied to order in lengths longer than 2 m. For aggressive environments, we recommend that ceiling bracket MTI is supplied with internal epoxy coating.

Escutcheon plate MTI CT

Designation for model 50 and 75		Weight gr
MTI CT		50

Escutcheon plate, used together with ceiling mount MTI for stabilising and to cover holes in false ceilings. Made completely from polypropylene.

Ceiling bracket MTF

Designation for model 50 and 75		Weight kg
MTF	1000	4,20

Ceiling bracket for fitting through e.g. roof beams. Fixing plate is adjustable along whole length of aluminium tube, if required, aluminium profile can be cut to fit.

Wall bracket MVK

Designation for model 50 and 75			Weight
Standard	ESD	ATEX	kg
MVK	ES	EX	2,15

Wall bracket is always included in models with designation MV.

Flexible table bracket MBF/MBFC

Designation for model 50 och 75			Weight
Standard	ESD		kg
MBF	ES		0,75

Designation for model MBC 700-50 ES			Weight
Standard	ESD		kg
MBFC	ES		0,70

For fixed table mounting, mounting flanges are included in models with designation MB.

Pressure drop diagram Ceiling mount MTI

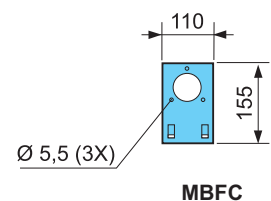
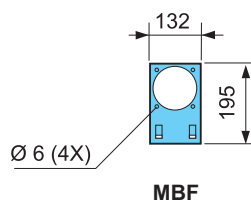
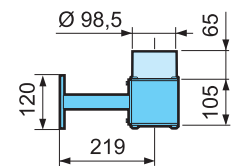
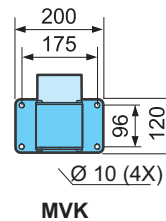
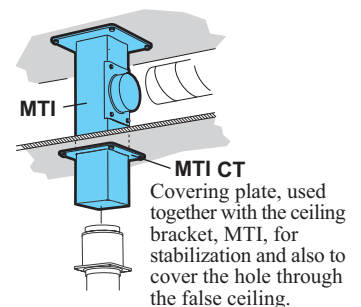
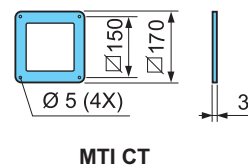
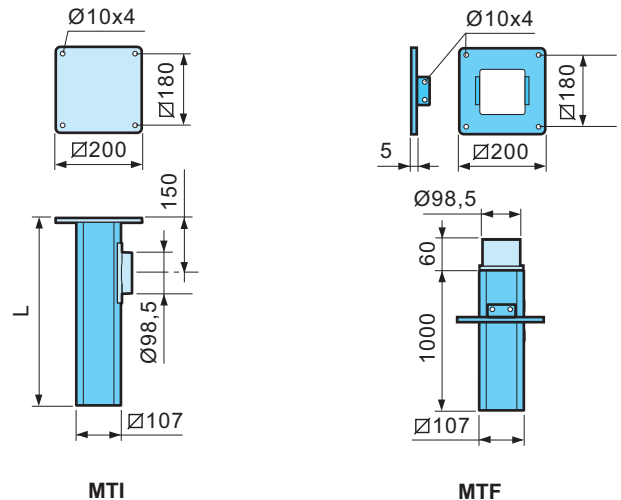
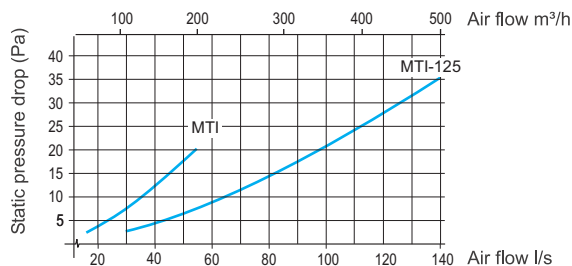

Material description

Friction joint

Ball-bearing supported adjustable friction joints in polypropylene (PP) with guide ring of low-friction treated rubber. Support springs and other attachment details in zinc plated steel or stainless steel.

Tube

Made from thin-wall anodised aluminium, alternatively from polypropylene. Air-tight damper supplied as standard.

Fan and filter

Connects to a separate fan, central extractor system or filter. Recommended operating temperature -15°C to +80°C.

Delivery

Ceiling- supplied assembled excluding hood or nozzle. Ceiling bracket MTI, or MTF, ordered separately.

Wall- assembled, complete with wall bracket MVK, excluding hood or nozzle.

Table- assembled, with mounting plate for table mounting, excluding hood or nozzle. Flexible table bracket MBF ordered separately.

MBC 700-50 ES- supplied assembled, complete with flexible nozzle MFS 600-50 ES and fixing plate for table mounting. Swivel function 90° between aluminium tube and plastic joint. Connection Ø 52.6 mm. Flexible table bracket MBFC ordered separately.

TERFU model 100

Model with three joints

Ceiling mount

Designation for model 100			Size (mm)		Weight	Gas springs
Standard	PP	ATEX	A	B	kg	st
MT 1150-100	PP	EX	450	350	4,5	0
MT 1350-100	PP	EX	550	450	5	0
MT 1650-100	PP	EX	750	550	5,5	1
MT 1900-100	PP	EX	1000	550	6	1
MT 2100-100	PP	EX	1000	750	6,5	2
MT 2650-100	PP	EX	1300	1000	7	2

Wall mount

Designation for model 100			Size (mm)		Weight	Gas springs
Standard	PP	ATEX	A	B	kg	st
MV 1150-100	PP	EX	450	350	7	0
MV 1350-100	PP	EX	550	450	7,5	0
MV 1650-100	PP	EX	750	550	8	1
MV 1900-100	PP	EX	1000	550	8,5	1
MV 2100-100	PP	EX	1000	750	9	2
MV 2650-100	PP	EX	1300	1000	9,5	2

Table mount

Designation for model 100			Size (mm)		Weight	Gas springs
Standard	PP	ATEX	A	B	kg	st
MB 1150-100	PP	EX	450	350	4,5	0
MB 1350-100	PP	EX	550	450	5	0
MB 1650-100	PP	EX	750	550	5,5	1
MB 1900-100	PP	EX	1000	550	6	1

Ceiling bracket MTI-125

Designation for model 100		Size	Weight
Standard	ATEX	(mm)	kg
MTI 500-125	EX	500	4,90
MTI 750-125	EX	750	5,80
MTI 1000-125	EX	1000	6,75
MTI 1250-125	EX	1250	7,65
MTI 1500-125	EX	1500	8,60
MTI 1750-125	EX	1750	9,50
MTI 2000-125	EX	2000	10,40

Ceiling mounting can be fitted with sleeves both below and above a false ceiling, in the latter case preferably together with MTI CT.

MTI can be supplied in lengths over 2m to order. For aggressive environments, we recommend that ceiling mount MTI is supplied with internal epoxy coating.

Escutcheon plate MTI CT-125

Designation for model 125	Weight gr.
MTI CT-125	125

Escutcheon plate, used together with ceiling mount MTI for stabilising and to cover holes in false ceilings. Made completely from polypropylene.

Wall bracket MVK-125

Designation for model 100		Weight
Standard	ATEX	kg
MVK-125	EX	2,50

Wall bracket is always included in models with designation MV.

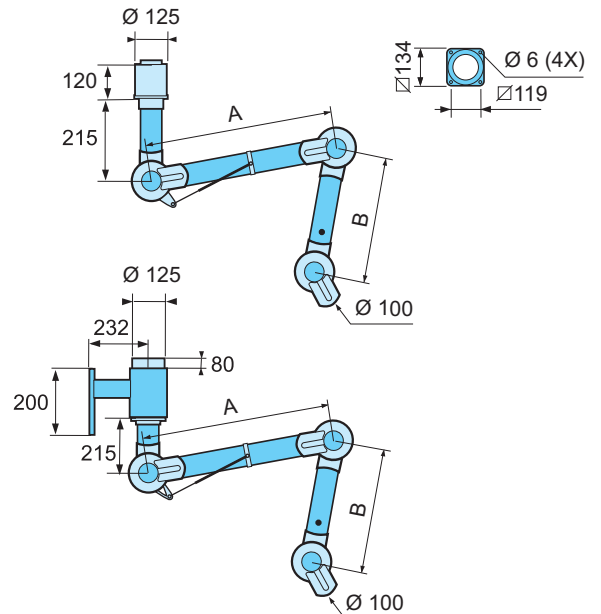

Extractors with designation MV always include a wall bracket

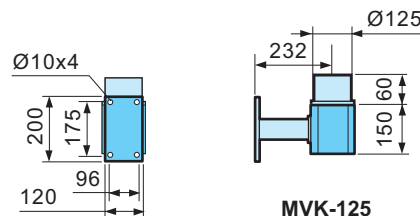
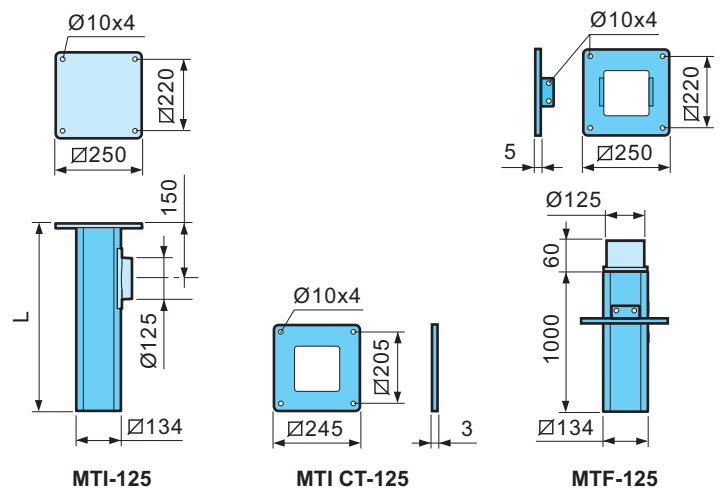
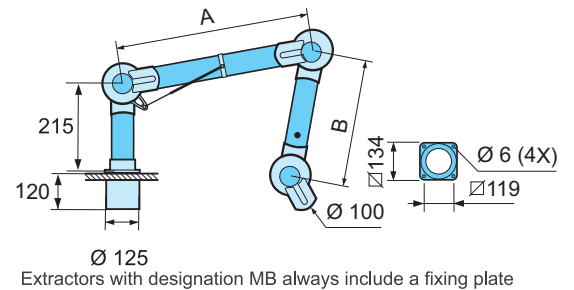

Material description

Friction joint

Ball-bearing supported adjustable friction joints in polypropylene (PP) with guide ring of low-friction treated rubber. Support springs and other attachment details in zinc plated steel or stainless steel.

Tube

Made from thin-wall anodised aluminium, alternatively from polypropylene. Air-tight damper supplied as standard.

Fan and filter

Connects to a separate fan, central extractor system or filter. Recommended operating temperature -15°C to +80°C.

Delivery

Ceiling- supplied assembled excluding hood. Ceiling bracket MTI-125 is ordered separately.

Wall- supplied assembled, complete with wall bracket MVK-125, excluding hood.

Table- supplied assembled, with mounting plate for table mounting, excluding hood.

TERFU Hoods to model 50 and 75

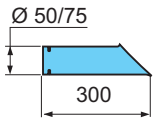

SUCTION NOZZLES

Suction nozzles are used for tough environments and to get close to the source of the contamination without disturbing the work.

Standard	PP	ESD	ATEX	weight gr
MS 300-50		ES		115
MS 300-75	PP	ES		160

Material

Standard/ES ... Aluminium
PP Polypropylene

Temp. range
-15°C to +80°C

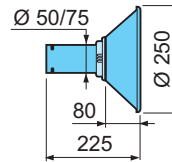

METAL HOODS

Metal hoods are used for work in tough environments. Capture of hot gases, dust spray, etc. Metal hoods can be equipped with a light.

Standard	PP	ESD	ATEX	weight gr
MM 250-50		ES		300
MM 250-75		ES	EX	335

Material

Standard/PP... Powdercoated aluminium
ES Aluminium
EX Aluminium

Temp. range
-15°C to +80°C

Accessory: Light rated at 50 W 230/12 VAC

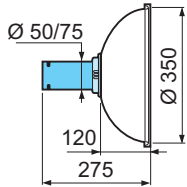

DOMED HOOD

Dome hoods are used to effectively cover the source of contamination without detracting from visibility.

Standard	PP	ESD	ATEX	weight gr
MK 350-50		ES		415
MK 350-75	PP	ES	EX	450

Material

Standard.. PETG
PP Polypropylene, opaque
ES PEEL black
EX PEEL black

Temp. range
-15°C to +80°C

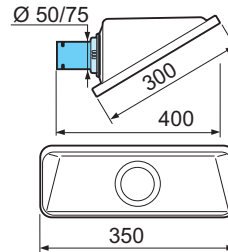

SQUARE HOOD

Square hoods are used to capture gases from above or from the sides close to the workplace. By using a well dimensioned size, it effectively captures volatile gases without hindering work under the hood.

Standard	PP	ESD	ATEX	weight gr
MSH 350-50				450
MSH 350-75				485

Material

Standard.. PETG

Temp. range
-15°C to +80°C

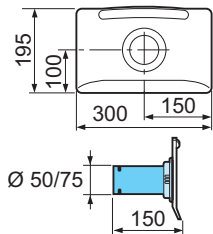

FLAT SCREEN HOOD

Flat screen hoods are designed to maximise the working area without obstructing the object from the user. Flat screen hoods give the best suction on tables and workbenches.

Standard	PP	ESD	ATEX	weight gr
MPH 300-50		ES		330
MPH 300-75	PP	ES	EX	365

Material

Standard.. PETG
PP Polypropylene, opaque
ES PEEL black
EX PEEL black

Temp. range
-15°C to +80°C

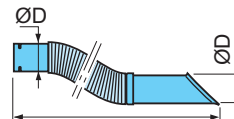

FLEXIBLE NOZZLES

Flexible nozzles are designed to maximise movement and ease of use without detracting from efficiency. Only as ESD version.

Designations	Size Ø D	Weight gr
MFS 600-50 ES	50	315
MFS 600-75 ES	75	425

Material

ES PEEL black

Temp. range
-15°C to +80°C

TERFU Hoods to model 100

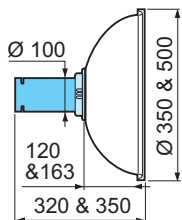

DOMED HOOD

Dome hoods are used to effectively cover the source of contamination without detracting from visibility.

Standard	PP	ESD	ATEX	weight gr
MK 351-100	PP		EX	610
MK 500-100	PP		EX	735

Material

Standard.. PETG
PP Polypropylene, opaque
ES PEEL black
EX PEEL black

Temp. range
-15°C to +80°C

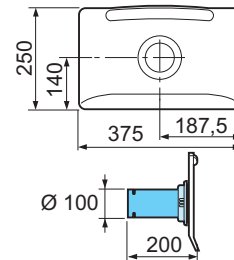

FLAT SCREEN HOOD

Flat screen hoods are designed to maximise the working area without obstructing the object from the user. Flat screen hoods give the best suction on tables and workbenches.

Standard	PP	ESD	ATEX	weight gr
MPH 375-100	PP	ES	EX	625

Material

Standard.. PETG
PP Polypropylene, opaque
ES PEEL black
EX PEEL black

Temp. range
-15°C to +80°C

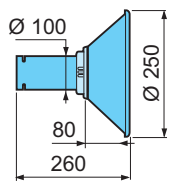

METAL HOODS

Metal hoods are used for work in tough environments. Capture of hot gases, dust spray, etc. Metal hoods can be equipped with work lighting.

Standard	PP	ESD	ATEX	weight gr
MM 251-100		ES	EX	510

Material

Standard ... Powdercoated aluminium
ES Aluminium
EX Aluminium

Temp. range
-15°C to +80°C

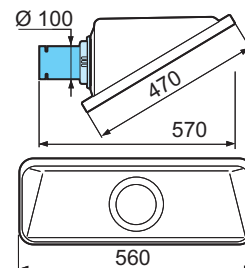

SQUARE HOOD

Square hoods are used to capture gases from above or from the sides close to the workplace. By using a well dimensioned size, it effectively captures volatile gases without hindering work under the hood.

Standard	PP	ESD	ATEX	weight gr
MSH 500-100				1125

Material

Standard.. PETG

Temp. range
-15°C to +80°C

Accessory: Light rated at 50 W 230/12 VAC

TERFU other accessories

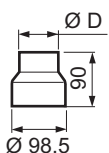

REDUCTION SLEEVE

Reduction, to suit standard mount Ø98,5 mm, for reduction to Ø75 and Ø50 mm.

Designations	Size Ø D	Weight gr
MRM 100-50	50	80
MRM 100-75	75	80

Material Polypropylene

Temp. range
-15°C to +80°C



PROTECTIVE GRILLE

Protective grille for mounting in joint. To prevent objects being sucked into the system.

Designations	Size Ø	Weight gr
MSG-75	75	7
MSG-100	100	12

Material Polypropylene

Temp. range
-15°C to +80°C

Typical values for Terfu 50 & 75

Size	Function	Air flow	
50 mm	Soldering	20 l/s	75 m ³ /h
	Hair dresser	17 l/s	60 m ³ /h
75 mm	Laboratory	40 l/s	150 m ³ /h
	Schools	40 l/s	150 m ³ /h

Typical values for Terfu 100

Size	Function	Air flow	
100 mm	Laboratory	40-80 l/s	150-300 m ³ /h
	Light industry:		
	- Gluing	80 l/s	300 m ³ /h
	- Solvents	80 l/s	300 m ³ /h
	- Brazing	100-125 l/s	350-450 m ³ /h
- Light welding/TIG	110-125 l/s	400-450 m ³ /h	

Range at recommended mounting height, Terfu 50 & 75

The following mounting heights and side displacements are recommended for optimization of evacuation

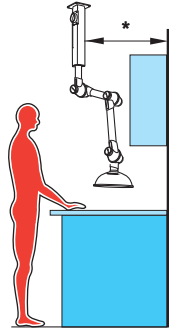

*For ceiling mounting the extractor is recommended to be positioned over the benchtop, taking other interior furnishing in consideration.

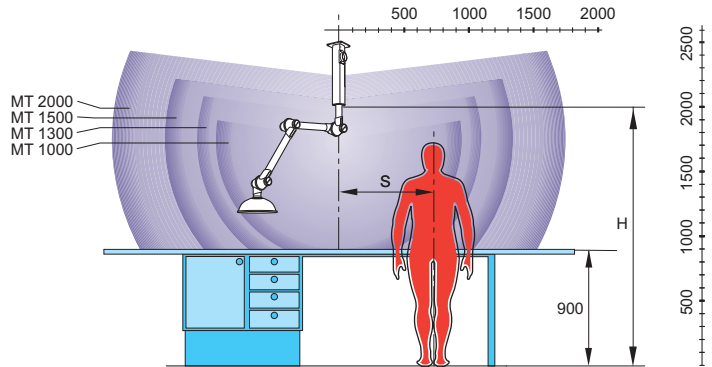

Recommended mounting height

Designation	H mm
MT 1000	1600-1900
MT 1300	1800-2100
MT 1500	1900-2200
MT 2000	2100-2400

Recommended side displacement in relation to workplace

Designation	S mm
MT 1000	300-600
MT 1300	400-700
MT 1500	500-800
MT 2000	700-1000

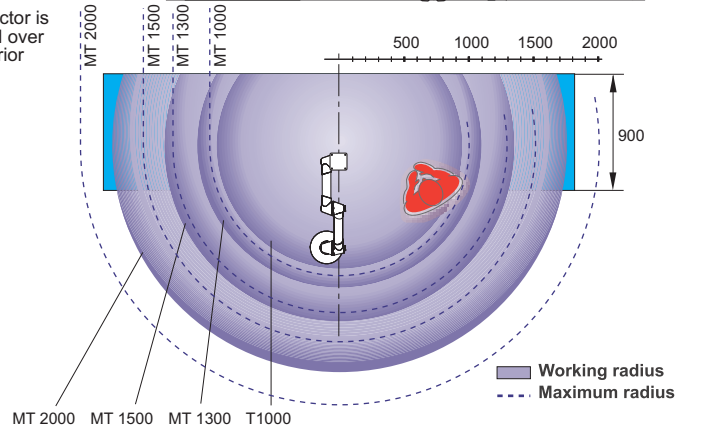

Range at recommended mounting height, Terfu 100

The following mounting heights and side displacements are recommended for optimization of evacuation

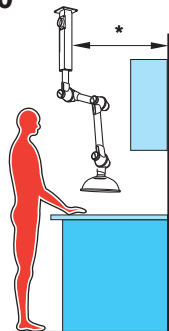

*For ceiling mounting the extractor is recommended to be positioned over the benchtop, taking other interior furnishing in consideration.

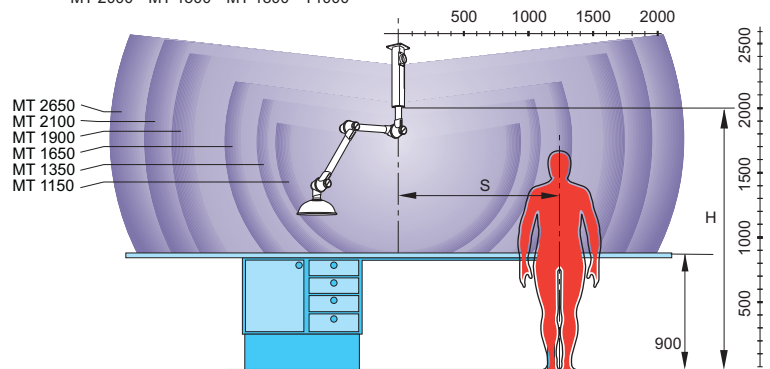

Recommended mounting height

Designation	H mm
MT 1150	1700-1900
MT 1350	1900-2100
MT 1650	2000-2200
MT 1900	2200-2400
MT 2100	2300-2500
MT 2650	2300-2500

Recommended side displacement in relation to workplace

Designation	S mm
MT 1150	300-600
MT 1350	400-700
MT 1650	500-800
MT 1900	700-800
MT 2100	700-900
MT 2650	900-1300

